

VNG

VNG MEDICAL
INNOVATION
SYSTEM



www.vngmedical.com



VNG-RW-1000

Every New Born Life Matters



About The Product

The open care warmer is designed to provide quick and effective treatment for the new born infants suffering from extreme heat loss. This equipment is suitable for NICU, labor rooms and nurseries.

The open care warmer consists of a cart and a bassinet assembly. A heater module within examination light and a pillar module which consists of a controller and SMPS. The basic unit is also equipped with one removable instrument tray which is mounted on the pillar module at rear of the bassinet.



Features

Heater Module

The radiant energy is directed by the parabolic reflectors on the infant. The radiant energy can be controlled either manually or by mean of skin temp sensor which controls the radiant energy to maintain a selected skin temperature.

Controller

When operated in manual control mode, the controller permits the operator to adjust the heat output of the heater module from zero to maximum settings. During the manual mode, a patient probe can be used to monitor the skin temperature. When operated in skin temperature control mode, the controller utilizes a skin temperature probe connected in between the controller input and the infant to automatically adjust the heat output of the heater module to maintain a selected preset skin temperature. Up and down switches permit adjustment of skin temp set point and a digital display provides temperature read out.

Examination light

- Dazzle-free observation light for examination of the infant.
- Dual side swivel heater provided access for x-ray and other procedure.

Apgar timer

- Apgar mode is used to take the infant Apgar score within specified time.
- Apgar mode is to start and stop just pressing Apgar switch.

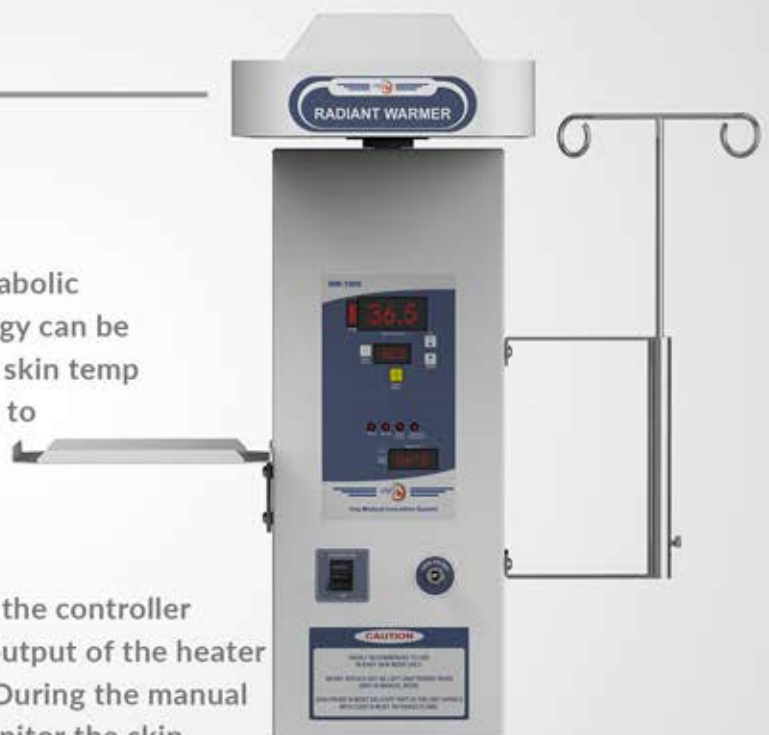

Alarm

Each time the unit is turned on, an automatic test sequence is initiated to verify that the visual display and the audible alarms are functional. Alarms are provided for high and low skin temperature.

Set point (high)

If the temperature sensed by the skin probe is 0.5 degree above the set temperature, a high set point alarm will occur after a delay of 10 second. The audible portion of the alarm can be silenced by depressing the alarm mute switch. However the visual indicator will continue. If the condition is not corrected within 20 sec the audible alarm will resume. When the alarm condition is corrected, the circuit will reset

Set point (low)

If the set temperature sensed by the skin probe is 0.5 degree less than the set point, a low set point alarm will occur after a delay of 10 seconds.

Probe fail

During skin control mode, if the skin temp probe is open short or un-plugged, the probe failure alarm will indicate the baby temperature display and the heater will be turned off. This alarm cannot be rest until the alarm condition is corrected.

Modes of Operation

There are two modes of operation for the VNG RWG 1000, they are as follows:

Servo mode

Manual mode

Servo mode

In this mode infant temperature is sensed with the help of a skin temperature probe. The heater power is automatically controlled so that infant temperature lies in the desired range. This is set by the user.

Manual mode

In this mode, we can manually set the power of the heater ranging from 10 percent to 100 percent.

Set temp range

Skin: 32 degrees to 38 degrees

Resolution: 0.1 degree

Accuracy: 0.2 degree

Electrical Specification

Power source - 220 volt Ac /50 Hz

Heater power - 650 Watt

Examination light - 9 watt

Power cable length - 3 meter

Fuse used - 4 Amperes

Mechanical specification

Paint & Coating - MS Fabrication with powder coating

Castor - Each unit has four castor, two lockable.

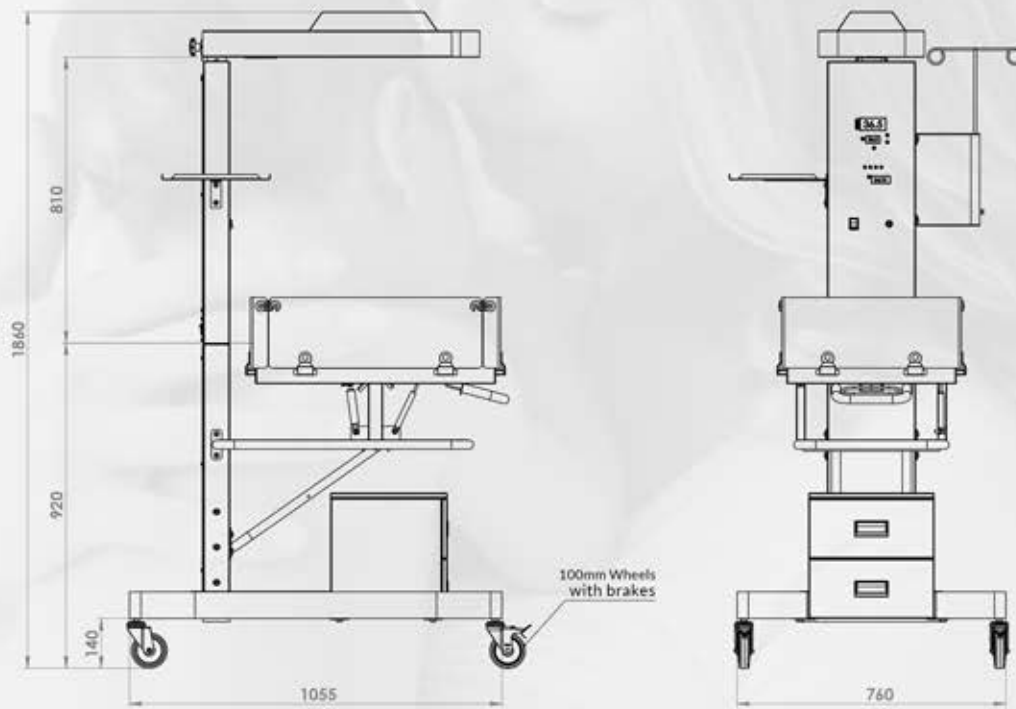

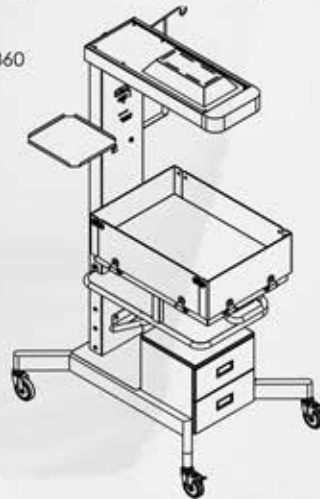

Overall dimensions = 1055x760x1860



All dimensions in mm

 Plot No. 197, JLPL Ind. Area,
Sector 82, Mohali, Punjab 140308

 +91 87 250-31075
0172 2970197

 vngmedical@yahoo.in

 www.vngmedical.com